

# Встроенные датчики загрязнения ICS

## Технические характеристики

По вопросам продаж и поддержки обращайтесь:

Алматы (727)345-47-04  
Ангарск (3955)60-70-56  
Архангельск (8182)63-90-72  
Астрахань (8512)99-46-04  
Барнаул (3852)73-04-60  
Белгород (4722)40-23-64  
Благовещенск (4162)22-76-07  
Брянск (4832)59-03-52  
Владивосток (423)249-28-31  
Владикавказ (8672)28-90-48  
Владимир (4922)49-43-18  
Волгоград (844)278-03-48  
Вологда (8172)26-41-59  
Воронеж (473)204-51-73  
Екатеринбург (343)384-55-89

Иваново (4932)77-34-06  
Ижевск (3412)26-03-58  
Иркутск (395)279-98-46  
Казань (843)206-01-48  
Калининград (4012)72-03-81  
Калуга (4842)92-23-67  
Кемерово (3842)65-04-62  
Киров (8332)68-02-04  
Коломна (4966)23-41-49  
Кострома (4942)77-07-48  
Краснодар (861)203-40-90  
Красноярск (391)204-63-61  
Курск (4712)77-13-04  
Курган (3522)50-90-47  
Липецк (4742)52-20-81

Магнитогорск (3519)55-03-13  
Москва (495)268-04-70  
Мурманск (8152)59-64-93  
Набережные Челны (8552)20-53-41  
Нижний Новгород (831)429-08-12  
Новокузнецк (3843)20-46-81  
Ноябрьск (3496)41-32-12  
Новосибирск (383)227-86-73  
Омск (3812)21-46-40  
Орел (4862)44-53-42  
Оренбург (3532)37-68-04  
Пенза (8412)22-31-16  
Петрозаводск (8142)55-98-37  
Псков (8112)59-10-37  
Пермь (342)205-81-47

Ростов-на-Дону (863)308-18-15  
Рязань (4912)46-61-64  
Самара (846)206-03-16  
Санкт-Петербург (812)309-46-40  
Саратов (845)249-38-78  
Севастополь (8692)22-31-93  
Саранск (8342)22-96-24  
Симферополь (3652)67-13-56  
Смоленск (4812)29-41-54  
Сочи (862)225-72-31  
Ставрополь (8652)20-65-13  
Сургут (3462)77-98-35  
Сыктывкар (8212)25-95-17  
Тамбов (4752)50-40-97  
Тверь (4822)63-31-35

Тольятти (8482)63-91-07  
Томск (3822)98-41-53  
Тула (4872)33-79-87  
Тюмень (3452)66-21-18  
Ульяновск (8422)24-23-59  
Улан-Удэ (3012)59-97-51  
Уфа (347)229-48-12  
Хабаровск (4212)92-98-04  
Чебоксары (8352)28-53-07  
Челябинск (351)202-03-61  
Череповец (8202)49-02-64  
Чита (3022)38-34-83  
Якутск (4112)23-90-97  
Ярославль (4852)69-52-93

Россия +7(495)268-04-70

Казахстан +(727)345-47-04

Беларусь +(375)257-127-884

Узбекистан +998(71)205-18-59

Киргизия +996(312)96-26-47

эл.почта: [mqt@nt-rt.ru](mailto:mqt@nt-rt.ru) || сайт: <https://mpfiltri.nt-rt.ru/>



The fluid is the vector that transmits power, energy within an oleodynamic circuit. In addition to transmitting energy through the circuit, it also performs additional functions such as lubrication, protection and cooling of the surfaces. The classification of fluids used in hydraulic systems is coded in many regulatory references, different Standards.

The most important classification system for hydraulic fluids is the one defined by International Organization for Standardization (ISO), which established a classification system within their standard: "ISO 6743-4 Lubricants, Industrial Oils and Related Products". In particular, the parts of interest for hydraulic fluids are:

- Lubricants, industrial oils and related products (class L)
- Classifications - Part 4L - Family H (Hydraulic systems)

The ISO 6743-4 classification system can be generally applied to the three primary classes of hydraulic fluids:

- Mineral Oils (i.e.: petroleum) Hydraulic Fluids (i.e.: HH: Mineral lubricants without corrosion inhibitors; HL: HH-type lubricants with oxidation reduction and anticorrosive additives; HM: HL-type lubricants with anti-wear additives; HV: HM-type lubricants with a higher viscosity grade and temperature properties; and others).
- Biodegradable Hydraulic Fluids (HExx), also defined as "Environmentally acceptable hydraulic fluids".
- Fire Resistant Hydraulic Fluids (HFxx), which could be further split into: Fire-resistant aqueous fluids (HFAx, HFB; HFC); Fire-resistant synthetic anhydrous fluids (HFDx).

The choice of fluid for an hydraulic system must take into account several parameters.

These parameters can adversely affect the performance of an hydraulic system, causing delay in the controls, pump cavitation, excessive absorption, excessive temperature rise, efficiency reduction, increased drainage, wear, jam/block or air intake in the plant.

The main properties that characterize hydraulic fluids and affect their choice are:

- **DYNAMIC VISCOSITY**  
It identifies the fluid's resistance to sliding due to the impact of the particles forming it.
- **KINEMATIC VISCOSITY**  
It is a widespread formal dimension in the hydraulic field.  
It is calculated with the ratio between the dynamic viscosity and the fluid density.  
Kinematic viscosity varies with temperature and pressure variations.
- **VISCOSITY INDEX**  
This value expresses the ability of a fluid to maintain viscosity when the temperature changes.  
A high viscosity index indicates the fluid's ability to limit viscosity variations by varying the temperature.
- **FILTERABILITY INDEX**  
It is the value that indicates the ability of a fluid to cross the filter materials.  
A low filterability index could cause premature clogging of the filter material.
- **WORKING TEMPERATURE**  
Working temperature affects the fundamental characteristics of the fluid.  
As already seen, some fluid characteristics, such as cinematic viscosity, vary with the temperature variation.

When choosing a hydraulic oil, must therefore be taken into account of the environmental conditions in which the machine will operate.

- **COMPRESSIBILITY MODULE**  
Every fluid subjected to a pressure contracts, increasing its density. The compressibility module identifies the increase in pressure required to cause a corresponding increase in density.
- **HYDROLYTIC STABILITY**  
It is the characteristic that prevents galvanic pairs that can cause wear in the plant/system.
- **ANTIOXIDANT STABILITY AND WEAR PROTECTION**  
These features translate into the capacity of a hydraulic oil to avoid corrosion of metal elements inside the system.
- **HEAT TRANSFER CAPACITY**  
It is the characteristic that indicates the capacity of hydraulic oil to exchange heat with the surfaces and then cool them.

## ② FLUID CONTAMINATION

Whatever the nature and properties of fluids, they are inevitably subject to contamination. Fluid contamination can have two origins:

- **INITIAL CONTAMINATION**  
Caused by the introduction of contaminated fluid into the circuit, or by incorrect storage, transport or transfer operations.
- **PROGRESSIVE CONTAMINATION**  
Caused by factors related to the operation of the system, such as metal surface wear, sealing wear, oxidation or degradation of the fluid, the introduction of contaminants during maintenance, corrosion due to chemical or electrochemical action between fluid and components, cavitation. The contamination of hydraulic systems can be of different nature:
- **SOLID CONTAMINATION**  
For example rust, slag, metal particles, fibers, rubber particles, paint particles or additives
- **LIQUID CONTAMINATION**  
For example, the presence of water due to condensation or external infiltration or acids
- **GASEOUS CONTAMINATION**  
For example, the presence of air due to inadequate oil level in the tank, drainage in suction ducts, incorrect sizing of tubes or tanks.

## ④ EFFECTS OF CONTAMINATION ON HYDRAULIC COMPONENTS

Solid contamination is recognized as the main cause of malfunction, failure and early degradation in hydraulic systems. It is impossible to delete it completely, but it can be effectively controlled by appropriate devices.

CONTAMINATION IN PRESENCE OF LARGE TOLERANCES



CONTAMINATION IN PRESENCE OF NARROW TOLERANCES



Solid contamination mainly causes surface damage and component wear.

- ABRASION OF SURFACES  
Cause of leakage through mechanical seals, reduction of system performance, failures.
- SURFACE EROSION  
Cause of leakage through mechanical seals, reduction of system performance, variation in adjustment of control components, failures.
- ADHESION OF MOVING PARTS  
Cause of failure due to lack of lubrication.
- DAMAGES DUE TO FATIGUE  
Cause of breakdowns and components breakdown.

ABRASION



EROSION



ADHESION

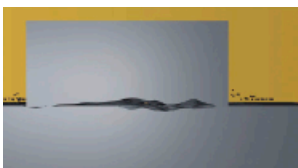

FATIGUE



Liquid contamination mainly results in decay of lubrication performance and protection of fluid surfaces.

### DISSOLVED WATER

- INCREASING FLUID ACIDITY  
Cause of surface corrosion and premature fluid oxidation
- GALVANIC COUPLE AT HIGH TEMPERATURES  
Cause of corrosion

### FREE WATER - ADDITIONAL EFFECTS

- DECAY OF LUBRICANT PERFORMANCE  
Cause of rust and sludge formation, metal corrosion and increased solid contamination
- BATTERY COLONY CREATION  
Cause of worsening in the filterability feature

- ICE CREATION AT LOW TEMPERATURES  
Cause damage to the surface
- ADDITIVE DEPLETION  
Free water retains polar additives

Gaseous contamination mainly results in decay of system performance.

- CUSHION SUSPENSION  
Cause of increased noise and cavitation.
- FLUID OXIDATION  
Cause of corrosion acceleration of metal parts.
- MODIFICATION OF FLUID PROPERTIES (COMPRESSIBILITY MODULE, DENSITY, VISCOSITY)  
Cause of system's reduction of efficiency and of control. It is easy to understand how a system without proper contamination management is subject to higher costs than a system that is provided.
- MAINTENANCE  
Increase maintenance activities, spare parts, machine stop costs.
- ENERGY AND EFFICIENCY  
Efficiency and performance reduction due to friction, drainage, cavitation.

## ⑤ MEASURING THE SOLID CONTAMINATION LEVEL

The level of contamination of a system identifies the amount of contaminant contained in a fluid. This parameter refers to a unit volume of fluid. The level of contamination may be different at different points in the system. From the information in the previous paragraphs it is also apparent that the level of contamination is heavily influenced by the working conditions of the system, by its working years and by the environmental conditions.

What is the size of the contaminating particles that we must handle in our hydraulic circuit?

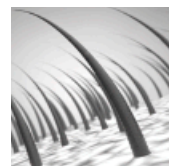

HUMAN HAIR  
(75 µm)

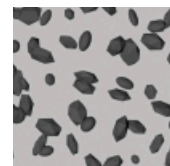

MINIMUM DIMENSION  
VISIBLE WITH HUMAN  
EYES  
(40 µm)

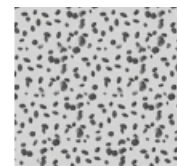

TYPICAL CONTAMINANT  
DIMENSION IN A  
HYDRAULIC CIRCUIT  
(4 - 14 µm)

Contamination level analysis is significant only if performed with a uniform and repeatable method, conducted with standard test methods and suitably calibrated equipment. To this end, ISO has issued a set of standards that allow tests to be conducted and express the measured values in the following ways.

- GRAVIMETRIC LEVEL - ISO 4405

The level of contamination is defined by checking the weight of particles collected by a laboratory membrane. The membrane must be cleaned, dried and desiccated, with fluid and conditions defined by the Standard. The volume of fluid is filtered through the membrane by using a suitable suction system. The weight of the contaminant is determined by checking the weight of the membrane before and after the fluid filtration.



CLEAN  
MEMBRANE

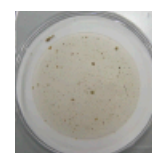

CONTAMINATED  
MEMBRANE

# CONTAMINATION MANAGEMENT

## - CUMULATIVE DISTRIBUTION OF THE PARTICLES SIZE - ISO 4406

The level of contamination is defined by counting the number of particles of certain dimensions per unit of volume of fluid. Measurement is performed by Contamination Monitoring Products (CMP).

Following the count, the contamination classes are determined, corresponding to the number of particles detected in the unit of fluid.

The most common classification methods follow ISO 4406 and SAE AS 4059 (Aerospace Sector) regulations.

NAS 1638 is still used although obsolete.

### Classification example according to ISO 4406

The International Standards Organization standard ISO 4406 is the preferred method of quoting the number of solid contaminant particles in a sample. The level of contamination is defined by counting the number of particles of certain dimensions per unit of volume of fluid. The measurement is performed by Contamination Monitoring Products (CMP).

The numbers represent a code which identifies the number of particles of certain sizes in 1ml of fluid. Each code number has a particular size range. The first scale number represents the number of particles equal to or larger than 4  $\mu\text{m}_{(c)}$  per millilitre of fluid;

The second scale number represents the number of particles equal to or larger than 6  $\mu\text{m}_{(c)}$  per millilitre of fluid;

The third scale number represents the number of particles equal to or larger than 14  $\mu\text{m}_{(c)}$  per millilitre of fluid.

ISO 4406 - Allocation of Scale Numbers

Class	Number of particles per ml	
	Over	Up to
28	1 300 000	2 500 000
27	640 000	1 300 000
26	320 000	640 000
25	160 000	320 000
24	80 000	160 000
23	40 000	80 000
22	20 000	40 000
21	10 000	20 000
20	5 000	10 000
19	2 500	5 000
18	1 300	2 500
17	640	1 300
16	320	640
15	160	320
14	80	160
13	40	80
12	20	40
11	10	20
10	5	10
9	2.5	5
8	1.3	2.5
7	0.64	1.3
6	0.32	0.64
5	0.16	0.32
4	0.08	0.16
3	0.04	0.08
2	0.02	0.04
1	0.01	0.02
0	0	0.01

- > 4  $\mu\text{m}_{(c)}$  = 350 particles
  - > 6  $\mu\text{m}_{(c)}$  = 100 particles
  - > 14  $\mu\text{m}_{(c)}$  = 25 particles
- 16 / 14 / 12

## ISO 4406 Cleanliness Code System

Microscope counting examines the particles differently to Contamination Monitoring Products (CMP) and the code is given with two scale numbers only. These are at 5  $\mu\text{m}$  and 15  $\mu\text{m}$  equivalent to the 6  $\mu\text{m}_{(c)}$  and 14  $\mu\text{m}_{(c)}$  of Contamination Monitoring Products (CMP).

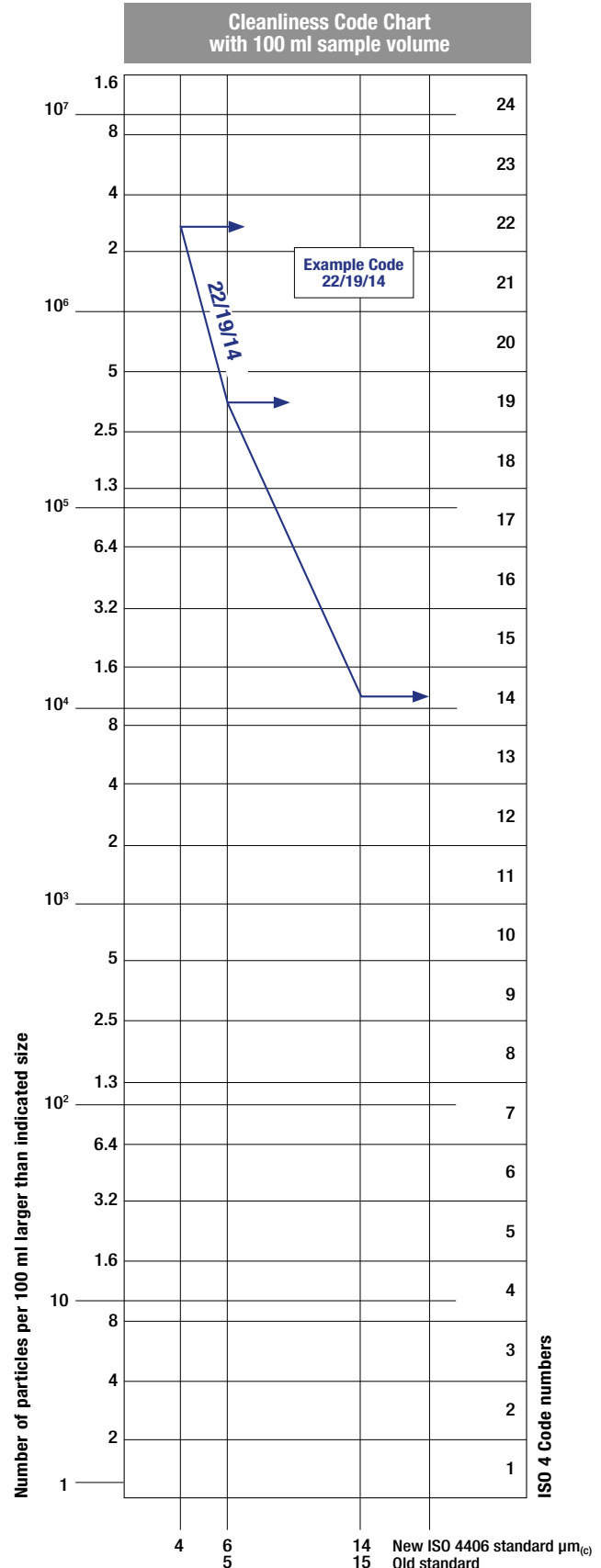

- CUMULATIVE DISTRIBUTION OF THE PARTICLES SIZE  
SAE AS4059-1 and SAE AS4059-2

### Classification example according to SAE AS4059 - Rev. G

The code, prepared for the aerospace industry, is based on the size, quantity, and particle spacing in a 100 ml fluid sample. The contamination classes are defined by numeric codes, the size of the contaminant is identified by letters (A-F).

This SAE Aerospace Standard (AS) defines cleanliness levels for particulate contamination of hydraulic fluids and includes methods of reporting data relating to the contamination levels. Tables 1 and 2 below provide differential and cumulative particle counts respectively for counts obtained by an automatic particle counter, e.g. LPA3.

Table 1 - Class for differential measurement

Class	Dimension of contaminant Maximum Contamination Limits per 100 ml (3)				
	5-15 µm	15-25 µm	25-50 µm	50-100 µm	>100 µm (1)
	6-14 µm(c)	14-21 µm(c)	21-38 µm(c)	38-70 µm(c)	>70 µm(c) (2)
00	125	22	4	1	0
0	250	44	8	2	0
1	500	89	16	3	1
2	1 000	178	32	6	1
3	2 000	356	63	11	2
4	4 000	712	126	22	4
5	8 000	1 425	253	45	8
6	16 000	2 850	506	90	16
7	32 000	5 700	1 012	180	32
8	64 000	11 400	2 025	360	64
9	128 000	22 800	4 050	720	128
10	256 000	45 600	8 100	1 440	256
11	512 000	91 200	16 200	2 880	512
12	1 024 000	182 400	32 400	5 760	1 024

6 - 14 µm(c) = 15 000 particles
14 - 21 µm(c) = 2 200 particles
21 - 38 µm(c) = 200 particles
38 - 70 µm(c) = 35 particles
> 70 µm(c) = 3 particles
SAE AS4059 REV G - Class 6

(1) Size range, optical microscope, based on longest dimension as measured per AS598 or ISO 4407. (2) Size range CMP calibrated per ISO 11171 or an optical or electron microscope with image analysis software, based on projected area equivalent diameter. (3) Contamination classes and particle count limits are identical to NAS 1638.

Table 2 - Class for cumulative measurement

Class	Dimension of contaminant Maximum Contamination Limits per 100 ml					
	>1 µm	>5 µm	>15 µm	>25 µm	>50 µm	>100 µm (1)
	>4 µm(c)	>6 µm(c)	>14 µm(c)	>21 µm(c)	>38 µm(c)	>70 µm(c) (2)
000	195	76	14	3	1	0
00	390	152	27	5	1	0
0	780	304	54	10	2	0
1	1 560	609	109	20	4	1
2	3 120	1 217	217	39	7	1
3	6 250	2 432	432	76	13	2
4	12 500	4 864	864	152	26	4
5	25 000	9 731	1 731	306	53	8
6	50 000	19 462	3 462	612	106	16
7	100 000	38 924	6 924	1 224	212	32
8	200 000	77 849	13 849	2 449	424	64
9	400 000	155 698	27 698	4 898	848	128
10	800 000	311 396	55 396	9 796	1 696	256
11	1 600 000	622 792	110 792	19 592	3 392	512
12	3 200 000	1 245 584	221 584	39 184	6 784	1 024

> 4 µm(c) = 45 000 particles
> 6 µm(c) = 15 000 particles
> 14 µm(c) = 1 500 particles
> 21 µm(c) = 250 particles
> 38 µm(c) = 15 particles
> 70 µm(c) = 3 particle
SAE AS4059 REV G cpc* Class 6 6/6/5/5/4/2

\* cumulative particle count

(1) Size range, optical microscope, based on longest dimension as measured per AS598 or ISO 4407. (2) Size range, CMP calibrated per ISO 11171 or an optical or electron microscope with image analysis software, based on projected area equivalent diameter. (3) Contamination classes and particle count limits are identical to NAS 1638.

- CLASSES OF CONTAMINATION ACCORDING TO NAS 1638 (January 1964)

The NAS system was originally developed in 1964 to define contamination classes for the contamination contained within aircraft components.

The application of this standard was extended to industrial hydraulic systems simply because nothing else existed at the time.

The coding system defines the maximum numbers permitted of 100 ml volume at various size intervals (differential counts) rather than using cumulative counts as in ISO 4406. Although there is no guidance given in the standard on how to quote the levels, most industrial users quote a single code which is the highest recorded in all sizes and this convention is used on MP Filtri Contamination Monitoring Products (CMP).

The contamination classes are defined by a number (from 00 to 12) which indicates the maximum number of particles per 100 ml, counted on a differential basis, in a given size bracket.

Size Range Classes (in microns)

Class	Maximum Contamination Limits per 100 ml				
	5-15	15-25	25-50	50-100	>100
	5-15 µm	15-25 µm	25-50 µm	50-100 µm	>100 µm
00	125	22	4	1	0
0	250	44	8	2	0
1	500	89	16	3	1
2	1 000	178	32	6	1
3	2 000	356	63	11	2
4	4 000	712	126	22	4
5	8 000	1 425	253	45	8
6	16 000	2 850	506	90	16
7	32 000	5 700	1 012	180	32
8	64 000	11 400	2 025	360	64
9	128 000	22 800	4 050	720	128
10	256 000	45 600	8 100	1 440	256
11	512 000	91 200	16 200	2 880	512
12	1 024 000	182 400	32 400	5 760	1 024

5-15 µm = 42 000 particles
15-25 µm = 2 200 particles
25-50 µm = 150 particles
50-100 µm = 18 particles
> 100 µm = 3 particles
Class NAS 8

- CUMULATIVE DISTRIBUTION OF THE PARTICLES SIZE - ISO 4407

The level of contamination is defined by counting the number of particles collected by a laboratory membrane per unit of fluid volume. The measurement is done by a microscope. The membrane must be cleaned, dried and desiccated, with fluid and conditions defined by the Standard. The fluid volume is filtered through the membrane, using a suitable suction system.

The level of contamination is identified by dividing the membrane into a predefined number of areas and by counting the contaminant particles using a suitable laboratory microscope.

MICROSCOPE CONTROL AND MEASUREMENT



Example figure 1 and 2

COMPARISON PHOTOGRAPH'S  
1 graduation = 10µm



Fig. 1

Fig. 2

# CONTAMINATION MANAGEMENT

## - CLEANLINESS CODE COMPARISON

Although ISO 4406 standard is being used extensively within the hydraulics industry other standards are occasionally required and a comparison may be requested. The table below gives a very general comparison but often no direct comparison is possible due to the different classes and sizes involved.

ISO 4406	SAE AS4059 Table 2	SAE AS4059 Table 1	NAS 1638
> 4 $\mu\text{m}_{(c)}$ 6 $\mu\text{m}_{(c)}$ 14 $\mu\text{m}_{(c)}$	> 4 $\mu\text{m}_{(c)}$ 6 $\mu\text{m}_{(c)}$ 14 $\mu\text{m}_{(c)}$	4-6 6-14 14-21 21-38 38-70 >70	5-15 15-25 25-50 50-100 >100
23 / 21 / 18	13A / 12B / 12C	12	12
22 / 20 / 17	12A / 11B / 11C	11	11
21 / 19 / 16	11A / 10B / 10C	10	10
20 / 18 / 15	10A / 9B / 9B	9	9
19 / 17 / 14	9A / 8B / 8C	8	8
18 / 16 / 13	8A / 7B / 7C	7	7
17 / 15 / 12	7A / 6B / 6C	6	6
16 / 14 / 11	6A / 5B / 5C	5	5
15 / 13 / 10	5A / 4B / 4C	4	4
14 / 12 / 09	4A / 3B / 3C	3	3

## 6 FILTRATION TECHNOLOGIES

Various mechanisms such as mechanical stoppage, magnetism, gravimetric deposit, or centrifugal separation can be used to reduce the level of contamination.

The mechanical stoppage method is most effective and can take place in two ways:

### - SURFACE FILTRATION

It is by direct interception. The filter prevents particles larger than the pores from continuing in the plant / system. Surface filters are generally manufactured with metal canvases or meshes.

### - DEPTH FILTERING

Filters are constructed by fiber interlacing. Such wraps form pathways of different shapes and sizes in which the particles remain trapped when they find smaller apertures than their diameter.

Depth filters are generally produced with papers impregnated with phenolic resins, metal fibers or inorganic fibers.

In inorganic fiber filtration, commonly called microfibre, the filtering layers are often overlapped in order to increase the ability to retain the contaminant.

WIRE MESH FILTRATION

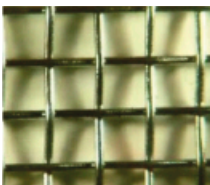

PAPER FILTRATION



MICROFIBER FILTRATION

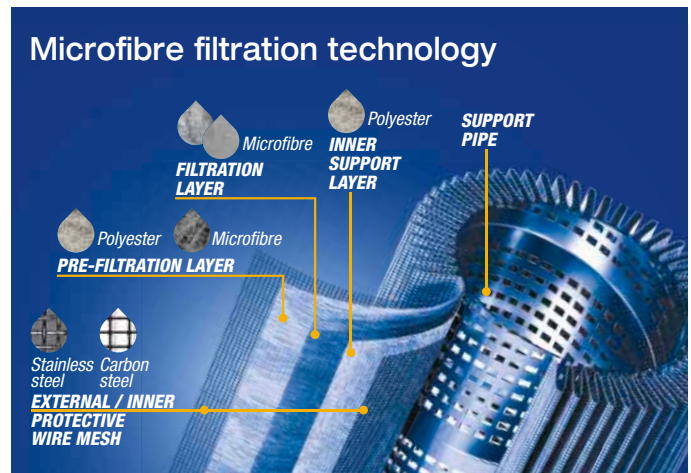
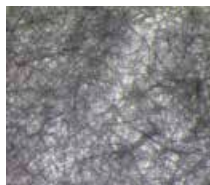

The filtration efficiency of metallic mesh filtrations is defined as the maximum particle size that can pass through the meshes of the filtering grid.

The efficiency of microfibre and paper filtration ( $\beta_{x(c)}$ ) is defined through a lab test called Multipass Test. The efficiency value ( $\beta_{x(c)}$ ) is defined as the ratio between the number of particles of certain dimensions detected upstream and downstream of the filter.

$$\frac{\text{Upstream particles number} > X \mu\text{m}_{(c)}}{\text{Downstream particles number} > X \mu\text{m}_{(c)}} = \beta_{x(c)}$$



Value ( $\beta_{x(c)}$ )	2	10	75	100	200	1000
Efficiency	50%	90%	98.7%	99%	99.5%	99.9%

Test conditions, such as type of fluid to be used (MIL-H-5606), type of contaminant to be used (ISO MTD), fluid viscosity, test temperature, are determined by ISO 16889.

In addition to the filtration efficiency value during the Multipass test, other important features, such as filtration stability ( $\beta$  stability) and dirt holding capacity (DHC), are also tested.

Poor filtration stability is the cause of the filtering quality worsening as the filter life rises. Low dirt holding capacity causes a reduction in the life of the filter.

Filtration ISO Standard Comparison

$\beta_{x(c)} > 1000$ ISO 16889	$\beta_x > 200$ ISO 4572	MP Filtri Filter media code
5 $\mu\text{m}_{(c)}$	3 $\mu\text{m}$	A (00) 03
7 $\mu\text{m}_{(c)}$	6 $\mu\text{m}$	A (00) 06
10 $\mu\text{m}_{(c)}$	10 $\mu\text{m}$	A (00) 10
16 $\mu\text{m}_{(c)}$	18 $\mu\text{m}$	A (00) 16
21 $\mu\text{m}_{(c)}$	25 $\mu\text{m}$	A (00) 25

## 7 APPLICABLE STANDARDS FOR FILTER DEVELOPMENT

In order to obtain unique criteria for development and verification of the filters performance, specific regulations for the filters and filter elements testing have been issued by ISO. These norms describe the target, the methodology, the conditions and the presentation methods for the test results.

### ISO 2941

*Hydraulic fluid power -- Filter elements -- Verification of collapse/burst pressure rating*

This Standard describes the method for testing the collapse / burst resistance of the filter elements.

The test is performed by crossing the contaminated fluid filter element at a predefined flow rate. The progressive clogging of the filter element, determined by contamination, causes an increase in differential pressure.

### ISO 2942

*Hydraulic fluid power -- Filter elements -- Verification of fabrication integrity and determination of the first bubble point*

This Standard describes the method to verify the integrity of the assembled filter elements.

It can be used to verify the quality of the production process or the quality of the materials by verifying the pressure value of the first bubble point.

### ISO 2943

*Hydraulic fluid power -- Filter elements -- Verification of material compatibility with fluids*

This Standard describes the method to verify the compatibility of materials with certain hydraulic fluids.

The test is carried out by keeping the element (the material sample) immersed in the fluid under high or low temperature conditions for a given period of time and verifying the retention of the characteristics.

### ISO 3723

*Hydraulic fluid power -- Filter elements -- Method for end load test*

This Standard describes the method for verifying the axial load resistance of the filter elements.

After performing the procedure described in ISO 2943, the designed axial load is applied to the filter element. To verify the test results, then the test described in ISO 2941 is performed.

### ISO 3968

*Hydraulic fluid power -- Filters -- Evaluation of differential pressure versus flow characteristics*

This Standard describes the method for checking the pressure drop across the filter.

The test is carried out by crossing the filter from a given fluid and by detecting upstream and downstream pressures.

Some of the parameters defined by the Standard are the fluid, the test temperature, the size of the tubes, the position of the pressure detection points.

### ISO 16889

*Hydraulic fluid power -- Filters -- Multi-pass method for evaluating filtration performance of a filter element*

This Standard describes the method to check the filtration characteristics of the filter elements.

The test is performed by constant introduction of contaminant (ISO MTD). The characteristics observed during the test are the filtration efficiency and the dirty holding capacity related to the differential pressure.

### ISO 23181

*Hydraulic fluid power -- Filter elements -- Determination of resistance to flow fatigue using high viscosity fluid*

This Standard describes the method for testing the fatigue resistance of the filter elements. The test is carried out by subjecting the filter to continuous flow variations, thus differential pressure, using a high viscosity fluid.

### ISO 11170

*Hydraulic fluid power -- Sequence of tests for verifying performance characteristics of filter elements*

The Standard describes the method for testing the performance of filter elements. The protocol described by the regulations provides the sequence of all the tests described above in order to verify all the working characteristics (mechanical, hydraulic and filtration).

### ISO 10771-1

*Hydraulic fluid power -- Fatigue pressure testing of metal pressure-containing envelopes -- Test method*

This Standard describes the method to check the resistance of the hydraulic components with pulsing pressure.

It can be applied to all metal components (excluding tubes) subject to cyclic pressure used in the hydraulic field.

## Description

### Contamination Monitoring Products

#### In-line Contamination Sensor

The ICS automatically measures particulate contamination levels in various hydraulic fluids and is designed for industrial and mobile applications.

It is designed to be inline mounted directly to systems, where ongoing measurement or analysis is required and where space and costs are limited

### Features & Benefits

- Inline mounting
- 3-channel contamination measurement
- Measures ISO 4406
- Space-efficient design
- Robust build quality
- Pressure max. 420 bar (6091 psi)
- Environmental Protection:
  - Mobile version: IP69K
  - Industrial version: IP67
- Impact Protection:
  - Mobile version: IK04
  - Industrial version: IK04
- 4-20mA analogue output (Industrial)
- RS485 Modbus RTU (Industrial)
- CANbus (Mobile)



## Technical data

**Technology**

LED based light extinction  
automatic optical contamination sensor

**Particle Sizing**

>4, 6, 14  $\mu\text{m}_{(c)}$

**Analysis range**

ISO 4406 Codes 0 to 24 (test time dependent)

**Accuracy**

$\pm 1/2$  code for 4,6,14  $\mu\text{m}$  (c) across the analysis range

**Calibration**

Each unit individually calibrated with ISO Medium Test Dust (MTD)  
based on ISO 11171, on equipment certified by I.F.T.S. ISO 11943

**Operating Flow Rate**

20 to 400 ml/minute

**Viscosity range**

$\leq 1000$  cSt

**Fluid temperature**

Industrial version:

From -25 °C to +80 °C (from -13 °F to +176 °F)

Mobile version:

From -25 °C to +100 °C (from -13 °F to +212 °F)

**Ambient Temperature**

Industrial version:

From -25 °C to +80 °C (from -13 °F to +176 °F)

Mobile version:

From -25 °C to +80 °C (from -13 °F to +176 °F)

**Pressure**

Minimum: 0.5 bar / 7.25 psi

Maximum: 420 bar / 6091 psi

**Communication options**

Industrial Version: 4-20mA time multiplexed; RS485 Modbus RTU

Mobile Version: CANbus

**Environmental Protection**

Industrial version: IP67; Impact Protection IK04

Mobile version: IP69K; Impact Protection IK04

**Weight**

0.9 kg (2 lbs)

**Dimensions**

Industrial version:

Width 58 mm (2 9/32")

Height 68 mm (2 43/64")

Depth 50 mm (2")

Mobile version:

Width 58 mm (2 9/32")

Height 76 mm (3")

Depth 50 mm (2")

**Electrical Supply**

Industrial version: 24v DC +/- 20%

Mobile version: 9-36v DC

**Power consumption**

<1.5 W

**Outer Casing Finish**

Stainless steel 316

**Wetted parts**

M - C46400 Cu alloy, 316 stainless steel, PTFE, FR4, Sapphire, FPM

**Fluid compatibility**

Mineral oils, synthetic fluids

**Electrical load (Mobile version only)**

In accordance with ISO 16750-2

**Mechanical load (Mobile version only)**

In accordance with ISO 16750-3

**Cable**

Industrial version only: Electrical cable has to be ordered separately  
(optional accessory), MP Filtri item no. 13.061000 - ICU/ICS Cable M12  
4-pin 1.5m long.

**Scope of Supply**

- 1 x ICS\*
- 2 x Hard copy of calibration certificate
- 1 x Datasheet with installation guide and user manual
- 1 x Hard-copy quick start guide
- 1 x digital copy of user guides /software / drivers

\* Version as specified

## Dimensions

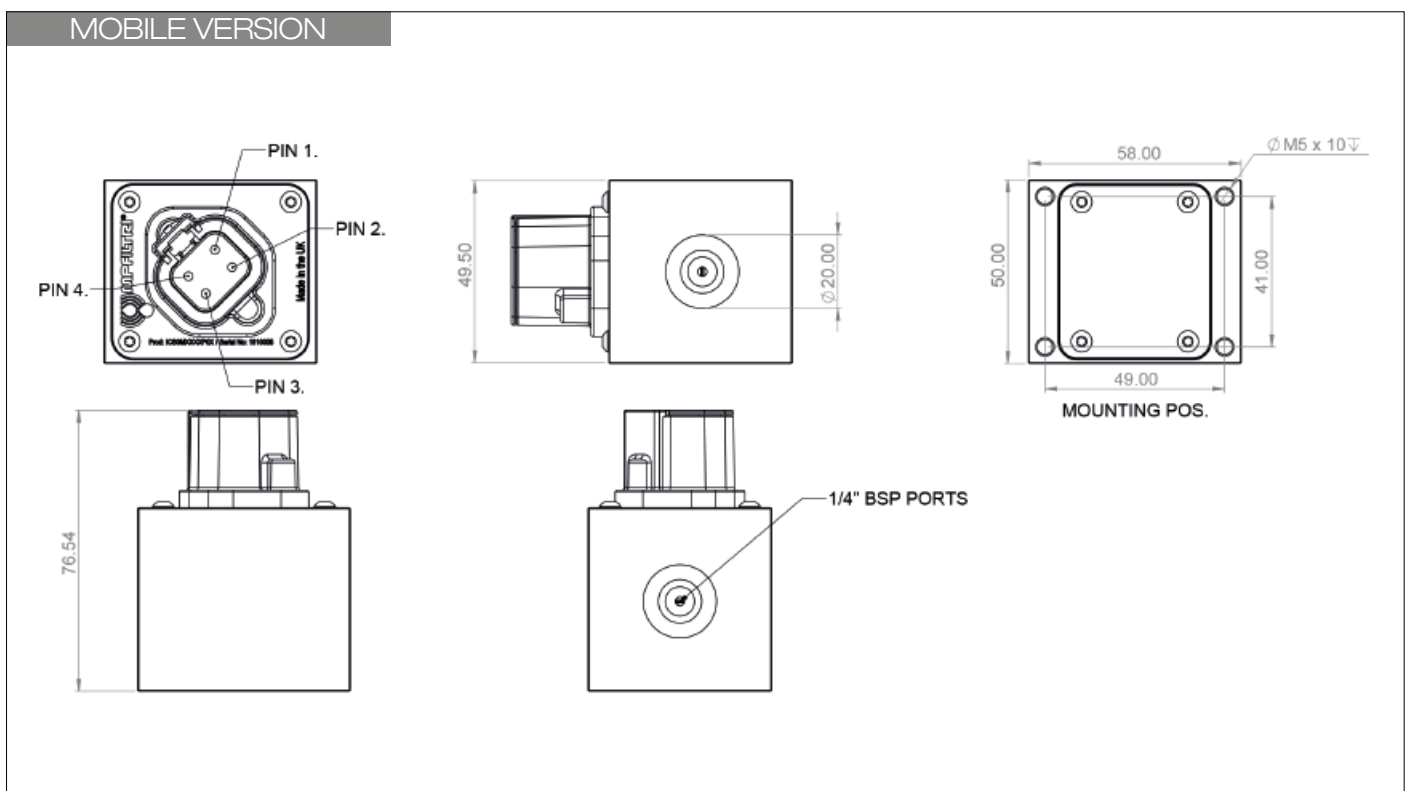
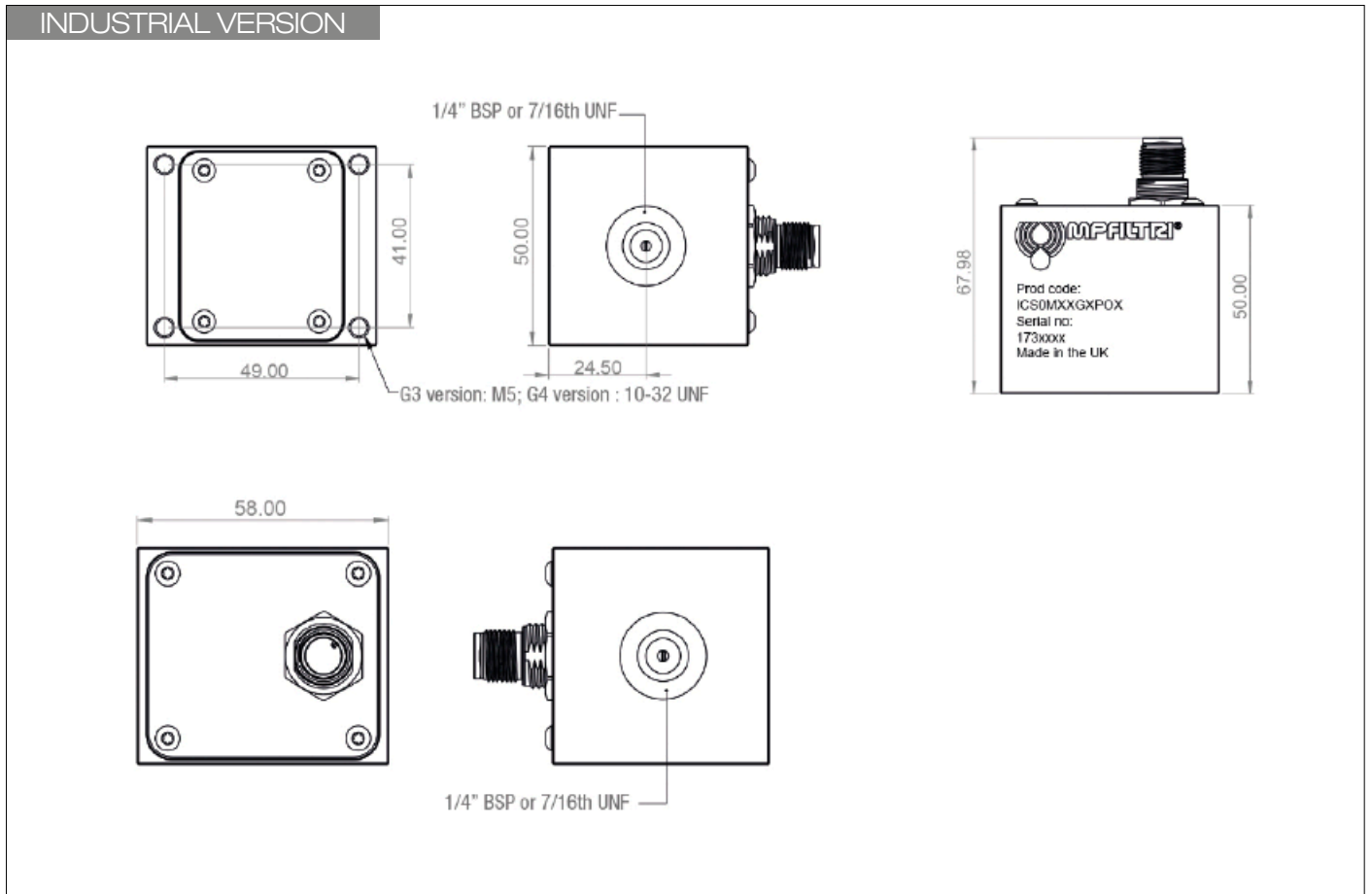

## Designation & Ordering code

ICS INLINE CONTAMINATION MONITORING SENSOR								
<b>Contamination Monitoring Product</b> <b>ICS</b> Inline Contamination Monitoring Sensor	Configuration example: <table border="1"><tr><td>ICS</td><td>0</td><td>M</td><td>0</td><td>0</td><td>G3</td><td>P01</td></tr></table>	ICS	0	M	0	0	G3	P01
ICS	0	M	0	0	G3	P01		
<b>Sensor options</b> <b>0</b> Standard								
<b>Fluid compatibility</b> <b>M</b> Mineral oil and synthetic fluids								
<b>Communication protocol</b> <b>0</b> 420mA <b>1</b> RS485 Modbus RTU <b>2*</b> CANBUS								
<b>Electric connection</b> <b>0</b> M12 4pin <b>1*</b> DTP10-4P								
<b>Port Options</b> <b>G3</b> 1/4" BSPP Female <b>G4</b> 7/16th UNF Female								
<b>Design Ref</b> <b>P01</b> Standard								

\* Mobile version only

## По вопросам продаж и поддержки обращайтесь:

Алматы (727)345-47-04  
Ангарск (3955)60-70-56  
Архангельск (8182)63-90-72  
Астрахань (8512)99-46-04  
Барнаул (3852)73-04-60  
Белгород (4722)40-23-64  
Благовещенск (4162)22-76-07  
Брянск (4832)59-03-52  
Владивосток (423)249-28-31  
Владикавказ (8672)28-90-48  
Владимир (4922)49-43-18  
Волгоград (844)278-03-48  
Вологда (8172)26-41-59  
Воронеж (473)204-51-73  
Екатеринбург (343)384-55-89

Иваново (4932)77-34-06  
Ижевск (3412)26-03-58  
Иркутск (395)279-98-46  
Казань (843)206-01-48  
Калининград (4012)72-03-81  
Калуга (4842)92-23-67  
Кемерово (3842)65-04-62  
Киров (8332)68-02-04  
Коломна (4966)23-41-49  
Кострома (4942)77-07-48  
Краснодар (861)203-40-90  
Красноярск (391)204-63-61  
Курск (4712)77-13-04  
Курган (3522)50-90-47  
Липецк (4742)52-20-81

Магнитогорск (3519)55-03-13  
Москва (495)268-04-70  
Мурманск (8152)59-64-93  
Набережные Челны (8552)20-53-41  
Новокузнецк (3843)20-46-81  
Ноябрьск (3496)41-32-12  
Новосибирск (383)227-86-73  
Омск (3812)21-46-40  
Орел (4862)44-53-42  
Оренбург (3532)37-68-04  
Пенза (8412)22-31-16  
Петрозаводск (8142)55-98-37  
Псков (8112)59-10-37  
Пермь (342)205-81-47

Ростов-на-Дону (863)308-18-15  
Рязань (4912)46-61-64  
Самара (846)206-03-16  
Санкт-Петербург (812)309-46-40  
Саратов (845)249-38-78  
Севастополь (8692)22-31-93  
Саранск (8342)22-96-24  
Симферополь (3652)67-13-56  
Смоленск (4812)29-41-54  
Сочи (862)225-72-31  
Ставрополь (8652)20-65-13  
Сургут (3462)77-98-35  
Сыктывкар (8212)25-95-17  
Тамбов (4752)50-40-97  
Тверь (4822)63-31-35

Тольятти (8482)63-91-07  
Томск (3822)98-41-53  
Тула (4872)33-79-87  
Тюмень (3452)66-21-18  
Ульяновск (8422)24-23-59  
Улан-Удэ (3012)59-97-51  
Уфа (347)229-48-12  
Хабаровск (4212)92-98-04  
Чебоксары (8352)28-53-07  
Челябинск (351)202-03-61  
Череповец (8202)49-02-64  
Чита (3022)38-34-83  
Якутск (4112)23-90-97  
Ярославль (4852)69-52-93

**Россия** +7(495)268-04-70

**Казахстан** +(727)345-47-04

**Беларусь** +(375)257-127-884

**Узбекистан** +998(71)205-18-59

**Киргизия** +996(312)96-26-47

эл.почта: [mqt@nt-rt.ru](mailto:mqt@nt-rt.ru) || сайт: <https://mpfiltri.nt-rt.ru/>